

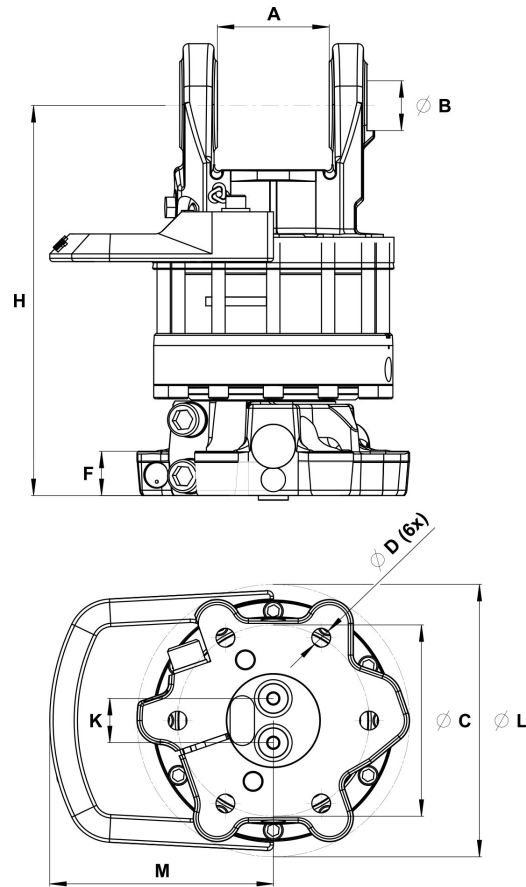

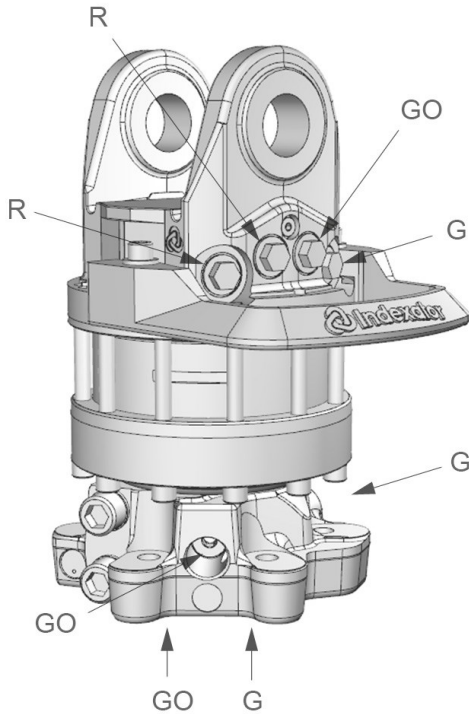







GV 17S

Part No.: 5217275



Upper connection	Lower connection
G 1/2	G 1/2

A: 101 mm	B: Ø45 mm	C: Ø173 mm	D: Ø17 mm	F: 40 mm	H: 353 mm	K: 40 mm	L: Ø248 mm	M: 202 mm
--------------	--------------	---------------	--------------	-------------	--------------	-------------	---------------	--------------

 63.6 kg	 360°	 Max 160 kN	 Max 50 kN	 3300 Nm	 Max 35 l/min	 Max 25 MPa	 Max 30 MPa	 Max 30 MPa
--	---	--	---	--	---	--	--	--

Adapter sets are available for alternative connections.

We reserve the right to make product changes. For further technical information relating to integration and hydraulic connections, please contact rotator@indexator.com